



Applications in timber construction with esb (elka strong board)

Information for the timber trade, timber housing developers, carpenters, roofers and others working with wood



THE BEST,
WHAT CAN HAPPEN
TO YOUR HOUSE

Can now also be used as an T+G under-ceiling board in accordance with ZVDH/Cologne



DIBt-Certificate No G-160-18-0004



Promoting Sustainable Forest Management
www.pefc.co.uk

www.blauer-engel.de/uz76



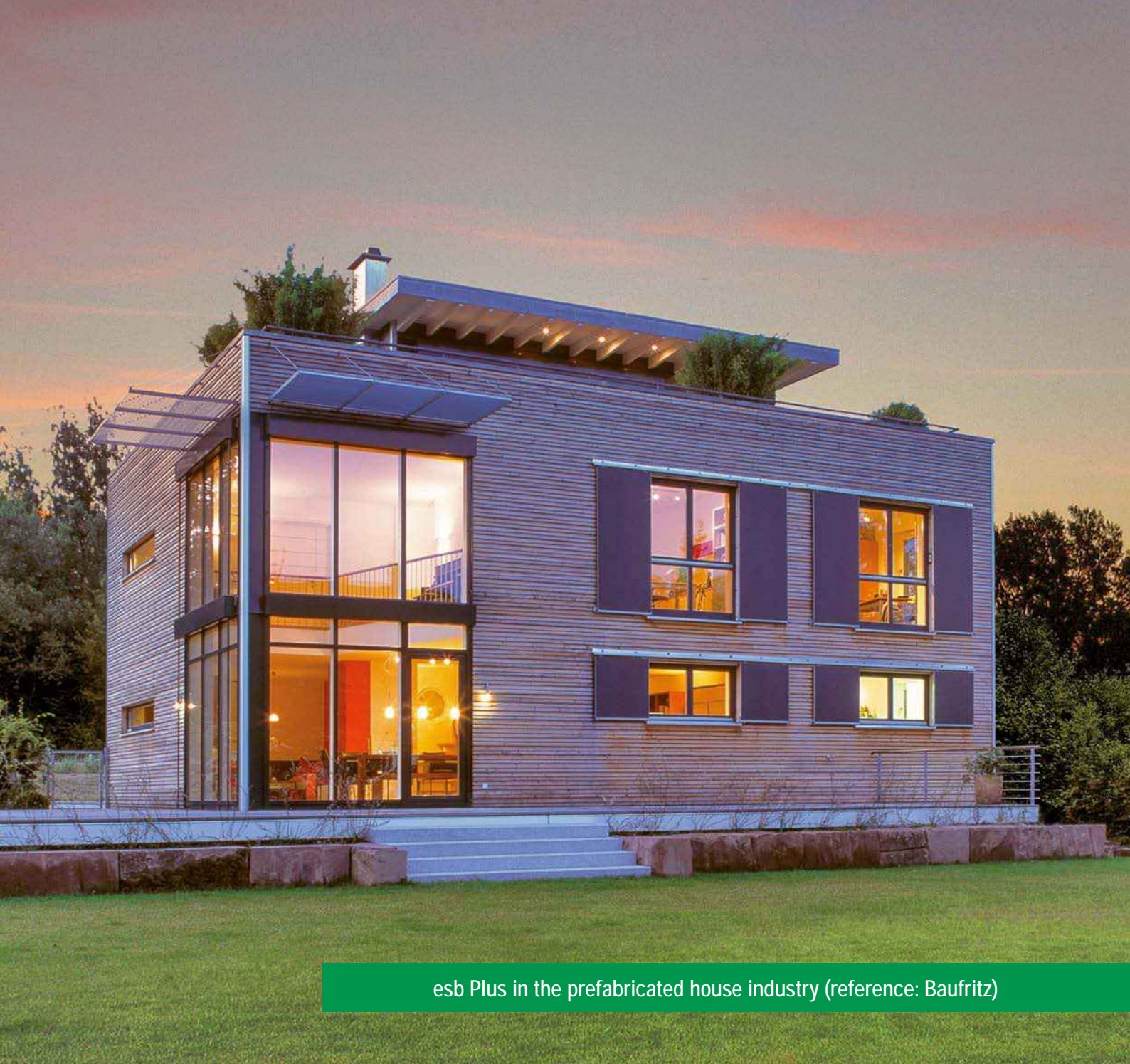

esb Plus in the prefabricated house industry (reference: Baufritz)



esb in property construction: 'Elefantenhaus' [Elephant House] in Zurich

Contents

1. elka-Holzwerke – our philosophy	3
2. elka strong board	4
3. Product advantages	
– Low emissions of formaldehyde and VOC'S	5
– Convincing technical values	5
– Superlative tongue and groove profile	6
– Almost entirely vapour-permeable	6
– Light and ground surface	6
4. Areas of application in timber construction	
– esb in walls	7
– esb in ceilings	8
– esb in flat roofs	9
– esb in roofs	12
5. Technical properties	13
6. Recommended applications	15
7. Delivery range and service	17

INTEGRATED LOCATION, MORBACH



PLANING SHOP

CHIPBOARD PLANT

NATURAL TIMBER
BOARD PLANT

SAWMILL

1. elka-Holzwerke – our philosophy

Wood is our passion

Wood and elka: A tradition

We love wood and believe in this raw material. After all, we have been working with it for over 100 years - now into our 4th generation. Back in 2014, the concept emerged at our integrated plant in Hunsrück to manufacture chipboard, sawn timber and natural timber boards. This is unique in our sector.

Wood and elka: Innovations

In close collaboration with the timber trade, our customers and suppliers, we ceaselessly continue to develop our products and to discover new and carefully thought out solutions. In particular, close cooperation with well-known research institutions enables us to drive forward our innovations. For example, we became known as an innovative company with our 'chipboard' products. We take pride in calling ourselves the raw chipboard specialist from Hunsrück.

Wood and elka: Sustainable timber products

Always in our sights: superlative technical properties, guided by ecological principles. Sustainable low-emission timber materials are always Job One for us. German certifications from the 'Sentinel Haus Institut' or the 'Blue Angel' such as the certification of the German DIBt (Deutsches Institut für Bautechnik) in 2019 confirm our resolve to continue along this path.

Wood and elka: Service orientation and high quality

Reliable planning is essential for any long-term business relationship. Our entire logistics operation is customer-focused because we can save our customers time by honouring our delivery commitments, or successfully supplying at short notice from our inventory range. Our quality management system guarantees high quality across all product lines. Leading purchasing associations in the timber trade as well as companies in Germany and abroad value our dependability as well, of course, as our wide range of products.

Wood and elka: Employees

We are committed to the power of togetherness - 200 employees engaged daily in seamless operations. Short decision-making routes facilitate efficient and therefore customer-oriented work. At the same time, you will find that operate personal and familiar structures. We take fair decisions based on partnership and we keep an overview of a wide and diverse range of needs - inside as well as outside the company.

2. esb strong board



Our esb board (elka strong board), developed in-house, is a timber particleboard for building as defined in DIN EN 312:2010. It possesses outstanding technical properties and is P5-graded for use in wetrooms. It is best suited for timber construction in buildings. This particleboard, bonded with synthetic resin, features a single-layer board structure with a combination of fresh timber sawdust grades.

An esb board is listed as a timber material for use in the building industry on 'Bauregelliste B' [German list of building rules], Part 1, under section 1.3.2.1, and is approved by building supervisory bodies.

Awards for esb Plus:

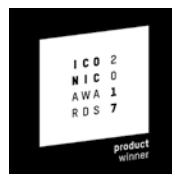

materialPREIS2018
Die Auszeichnung für besondere Materialien

Our raw materials

Sawdust residue, mainly spruce, from sustainably managed forestry from our own sawmill and from sawmills in the surrounding area. If so desired, can be PEFC or FSC-certified.

Our glue

Recycling-friendly and humidity-resistant MUF resin (melamine urea formaldehyde resin), made using our proprietary process to reduce formaldehyde emissions.

The two particleboards are certified with: DIBt-Certificate No G-160-18-0004

esb product information

esb Plus: Specifically developed and suitable for RAL-certified timber construction in buildings and pre-fabricated house construction with a formaldehyde content of ≤ 0.03 ppm.

esb^{Plus}

elka strong board Plus

esb standard: Formaldehyde content of $\leq 0,05$ ppm (E1E05) and superlative technical properties. This board is available as an esb cross-beam.

esb

elka strong board

3. Product advantages

The solution for healthy Building & Living

Low emissions of formaldehyde and VOCs

Low emissions are confirmed with various quality certificates. Our esb boards are free of old timber and the sawmill offcuts are sourced from sustainable forestry.

In addition, our esb boards have a low VOC content through the use of spruce offcuts (**VOC = Volatile Organic Compounds**).

Our esb Plus has been awarded the following certificates:

Trade fair dates:		3. Date	28th Date	
 www.blauer-engel.de/uz76 DER BLAUE ENGEL [THE BLUE ANGEL] (low-emissions) RAL UZ-76-2016	Formaldehyde content	-	≤ 0.08 mg/m ³	
	TVOC (C ₆ -C ₁₈)	≤ 3 mg/m ³	≤ 0.8 mg/m ³	
	TSVOC (C ₁₆ -C ₂₂)	-	≤ 0.1 mg/m ³	
	carcinogenic substances	-	≤ 1 µg/m ³	
	Total of all VOCs without NIK	≤ 10 µg/m ³ (total)	≤ 0.1 mg/m ³ (per individual value)	
	R value	-	≤ 1	
	Sentinel Haus Bauverzeichnis [SH Building Directory]			
	DGNB – Deutsche Gesellschaft für nachhaltiges Bauen [German society for sustainable building]			
Qualitätsgemeinschaft Holzwerkstoffe – Premium [Quality association for timber materials - premium]				
70% PEFC/FSC on request				
EPD – Institut Bauen und Umwelt [Building & Environment Institute]				

Convincing technical values

- Excellent static values (complies with EN 12369 Part 1 and ISO/IEC 20000-1) and technical values (complies with EN 13986 and/or EN 312)
- Greater transverse tensile strength than OSB3 (oriented-strand board) (around 40 % more)
- Bending strength and modulus of elasticity same in both directions
- Less swelling than with OSB 3

Technical properties¹⁾

Thickness [mm]	12	15	12 / 15	18	22 / 25	18–25	30
Type	esb P5		OSB 3	esb P5		OSB 3	esb P5
Transverse tensile strength [N/mm ²]	>0.45	>0.45	>0.32	>0.45	>0.40	>0.30	>0.35
Bending strength longitudinal [N/mm ²]	>18	>16	>20	>16	>14	>18	>12
Bending strength transverse [N/mm ²]	>18	>16	>10	>16	>14	>9	>12
24 hr soaking [%]	<11	<10	<15	<10	<10	<15	<10

¹⁾ The technical properties given for esb are in accordance with DIN EN 312 and for OSB in accordance with DIN 300; the actual values for esb boards are significantly better.

Thermal conductivity λ = 0.10 W/mK, Water vapour diffusion resistance factor (µ value) dry/humid = 80/40 according DIN EN 13986

3. Product advantages

Superlative tongue and groove profile

We guarantee an extremely precise fit with our partially tapered elka tongue and groove profile.

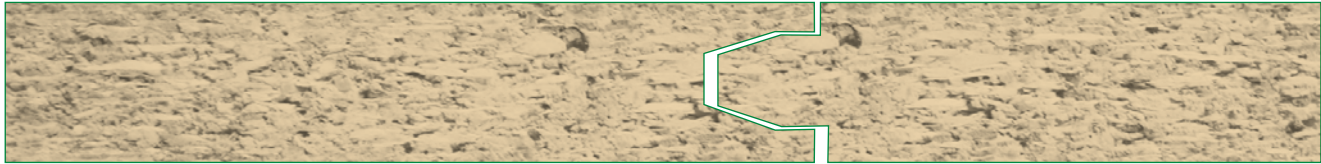

Almost entirely vapour-permeable

- Water vapour diffusion resistance factor (μ value) dry/humid = 80/40 according DIN EN 13986
- Just as heat always travels from the warm to the cold side, a process of compensation also takes place between areas with different levels of humidity. To ensure that this function continues unhindered, we can combine – if necessary - vapour barriers and our largely vapour-permeable esb panels in an intelligent way. This combination prevents condensation from building up – and therefore damage that would otherwise be caused to the building by damp. Esb panels are largely a vapour-permeable wood-based material that equalizes variations in the atmosphere indoors. esb panels have also proved to be valuable on external walls as well, e.g. as a support for rear-ventilated formwork or used in conjunction with vapour-permeable heat insulation.
- When used in this way, esb panels ensure that moisture is transported through the cross section of the wall. For a vapour-impermeable construction, an additional film can be fitted on the warmer side to act as a vapour retarder. This technology has been successfully used for decades in the prefabricated housing sector.

Light and ground surface and therefore:

- Possible to apply adhesives, paints and lacquers
- Virtually sealed surface
- Extremely precise fit
- natural wood character with light surface (spruce timber)

Further advantages

- Can now also be used as an N+F under-ceiling board in accordance with ZVDH/Cologne
- Meets IPPC standard ISPM No. 15 for wooden packaging
- The WUFI database or Ubakus.de can perform calculations of physical building structures

4. Areas of application in timber construction¹⁾

esb in walls

EXTERNAL WALL

External wall 1 - rear ventilation

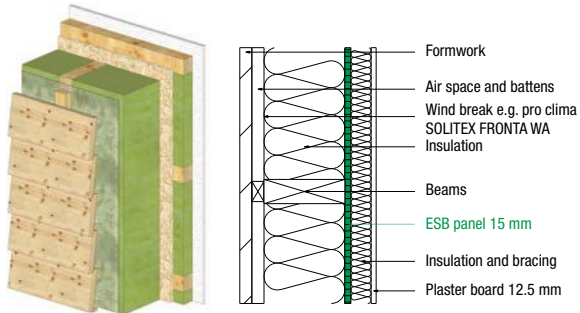

External wall 2 - rear ventilation

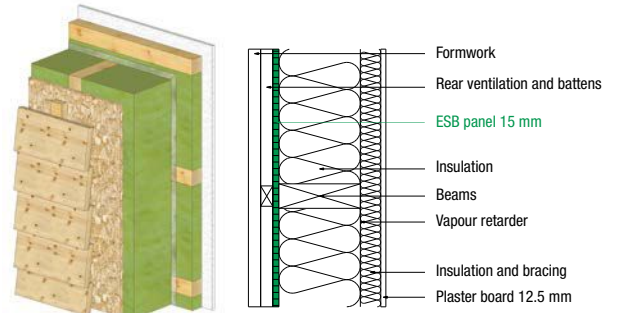

Exterior wall 3 –
with composite thermal insulation system, wood fibre

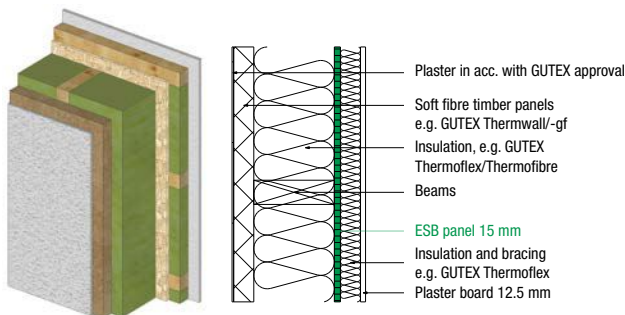

e.g. in acc. with General Construction Supervisory Approval [Allgemeine Bauaufsichtliche Zulassung] from Gutex Z-33.47-660

Exterior wall 4 –
with EPS composite thermal insulation system

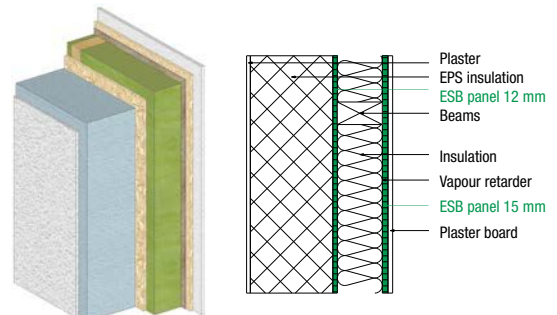

e.g. in accordance with approval no. Z-33.47-811 (STO) or no. Z-33.47-859 (STO) (simplified version) under German general building regulations.

INTERNAL WALL

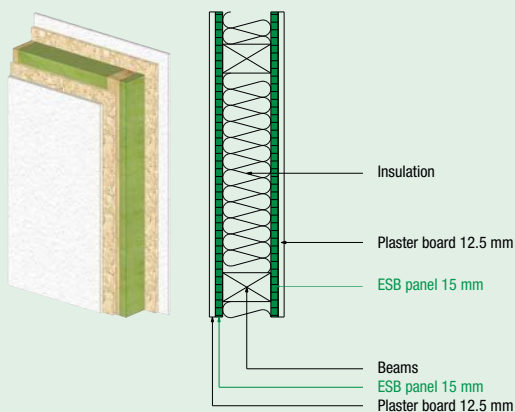

¹⁾ The structures illustrated in wall, ceiling and roof are just shown by way of example. They do not replace the physical structural calculation of specific buildings, that take all local conditions into account. The examples shown here provide information without assuring any properties.

4. Areas of application in timber construction¹⁾

esb in ceilings

Internal ceiling construction 1 -
in unheated room **GIVE ESB A GO!**

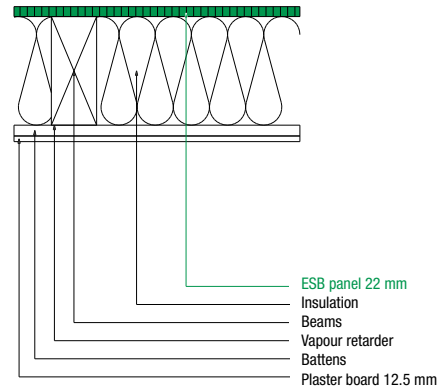
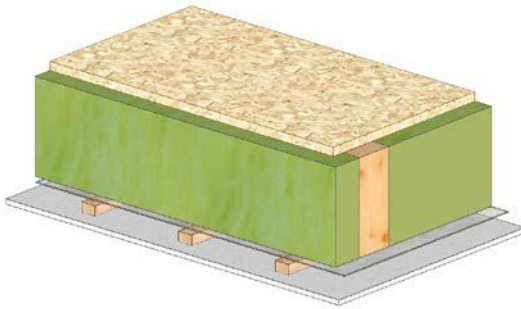

Internal ceiling construction 2 - in heated room

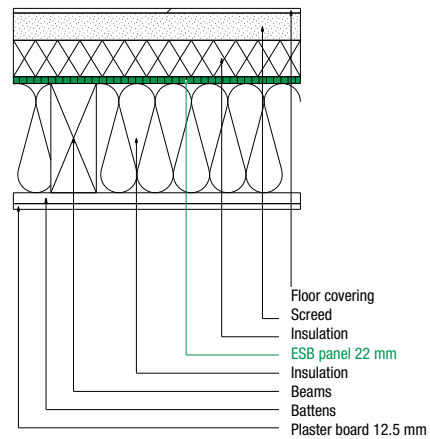
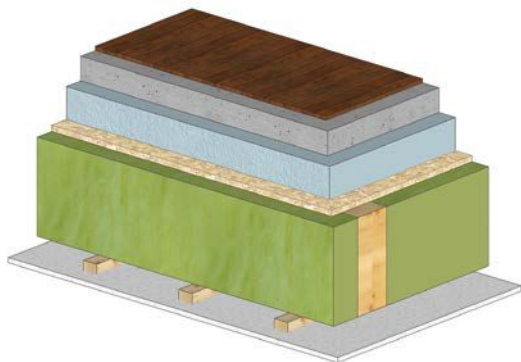

Internal ceiling construction 3 - in heated room

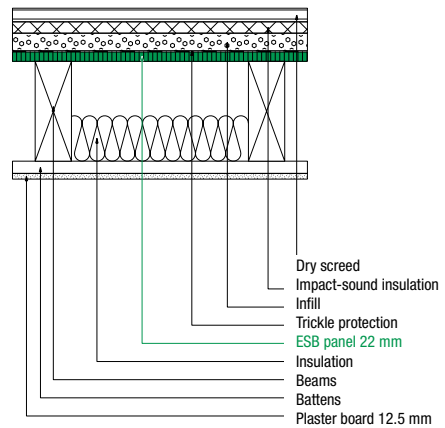
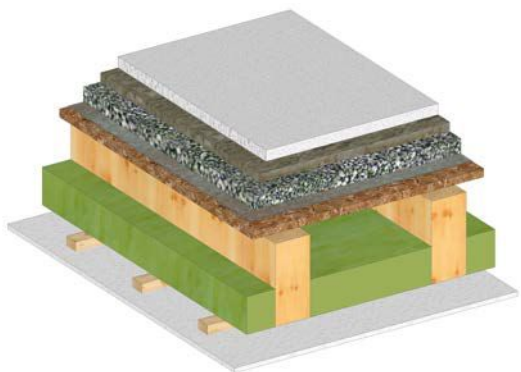

4. Areas of application in timber construction¹⁾

esb in flat roofs²⁾

Advantages and disadvantages of ventilated and unventilated structures, planning and implementation notes

FLAT ROOFS AND PITCHED FLAT ROOFS: Flat roofs are roof structures without or with shallow roof angles that have a water-impermeable layer right across the roof surface area, in acc. with DIN 68800-2 2012-02.

Advantages and disadvantages of ventilated and unventilated structures

VENTILATED STRUCTURES

Ventilated flat roofs are structures with two or more layers comprising an internal shell that encloses the space, an outer shell with sealing properties and an intermediate ventilation cavity with a layer of insulation.

ADVANTAGES	DISADVANTAGES
<ul style="list-style-type: none">– Protection against humidity (permeable design)– Summertime heat protection– More individual usage of the roof surface area	<ul style="list-style-type: none">– High component structures– More component layers– High cost of connections; ventilation level must not be interrupted. Inlet and outlet apertures must 'look good'– Higher costs

UNVENTILATED STRUCTURES

Unventilated flat roofs are single-layer structures (previously called 'hot roofs') where the roof structure is placed directly on top of its supporting structure.

ADVANTAGES	DISADVANTAGES
<ul style="list-style-type: none">– Compact design and high level of prefabrication– More effective use of components– Simple connection details	<ul style="list-style-type: none">– Challenging humidity management– Change in roof usage can require a new hygrothermal calculation– More prone to distortion

²⁾ Text contents, source: Information service, timber, flat roofs made of timber [Informationsdienst Holz, Flachdächer in Holzbauweise] (IHD Spezial 10/2008)

4. Areas of application in timber construction¹⁾

esb in flat roofs

Ventilated flat roofs

A distinction is made between constructions with ventilation on one plane of the load-bearing structure and/or the insulation (previously known as 'cold roofs', see Fig. 1) and fully-insulated constructions with ventilation under the roof skin (see Fig. 2) in which the roof seal is applied to an additional sub-structure. Freedom from damage in both cases depends largely on the functional integrity (i.e. the effectiveness) of the ventilation.

Fig. 1 - flat roof with ventilation below the roof skin

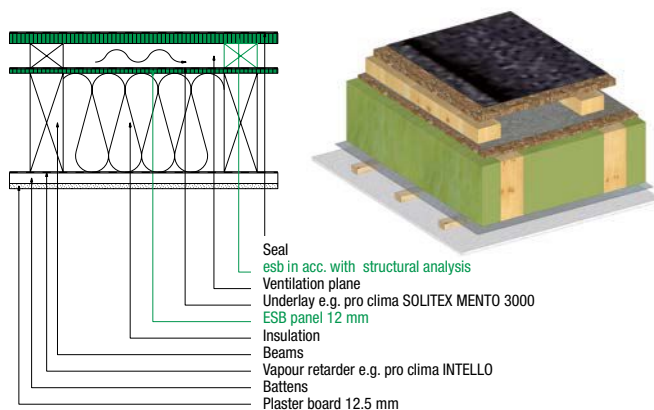

PRINCIPAL FEATURES

- + Formation of a gradient by the load-bearing structure
- + Computed condensate-free component
- + due to ventilation, usually no build-up of heat in summer
- high component superstructure with ventilation plane
- Secondary condensation may occur on the roof shell
- Insulation partially air-ventilated
- Heat dissipation by ventilation
- Noise emissions in ventilation plane
- Influence of heat-absorbent ceiling layers on the roof skin should be taken into account – structure to be classified as GK 2

Fig. 2 - full insulation with ventilation below the roof skin

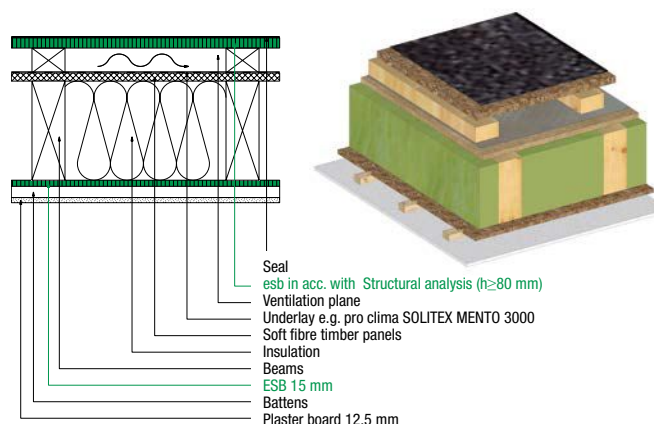

PRINCIPAL FEATURES

- + Ventilation height and where necessary gradient produced by means of opposing battens
- + Anti-sag support can be pre-fabricated as a sealed wooden panel construction element
- + Load-bearing structure GK 0 in acc. with DIN 68 800-2
- + permeable, air-tight construction
- + due to ventilation, usually no build-up of heat in summer
- high component superstructure with ventilation plane
- Secondary condensation may occur on the roof shell
- Influence of heat-absorbent ceiling layers on the roof skin should be taken into account

4. Areas of application in timber construction¹⁾

esb in flat roofs

Unventilated flat roofs

A distinction is made in timber construction between structures with insulation on the same plane as the load-bearing structure (see Fig. 3) and components primarily with insulation above the load-bearing structure (see Fig. 4). The latter are characterised by having their entire load-bearing timber structure inside the dry room climate.

Fig. 3 – Unventilated flat roof with full insulation on the load-bearing plane

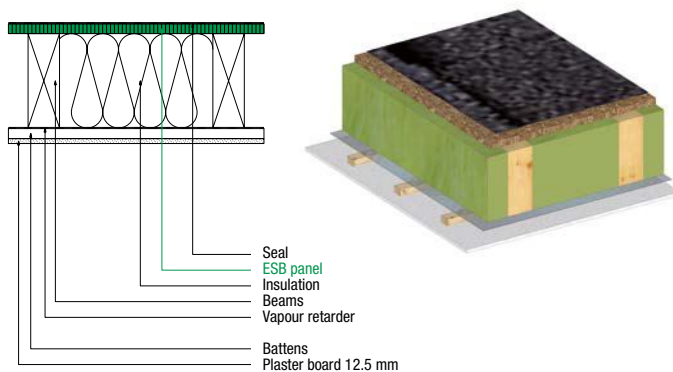

PRINCIPAL FEATURES

- + effective cross-section utilisation by means of insulation on the level of the open load-bearing structure
- + can be prefabricated as wood panel construction element
- + simple connection details because there are no ventilation inlets or outlets
- + with hygrothermic verification in acc. with DIN EN 15026, humidity-variable vapour retarders must hold DIBt (German construction supervisory authority) approval
- Classification in GK 0 in acc. with DIN 68 800-2
- Thermally insulating cover layers reduce drying capability
- Leaks in the external seal can lead to the ingress of humidity into the insulation level

Fig. 4 – Unventilated flat roof with additional insulation above the load-bearing plane

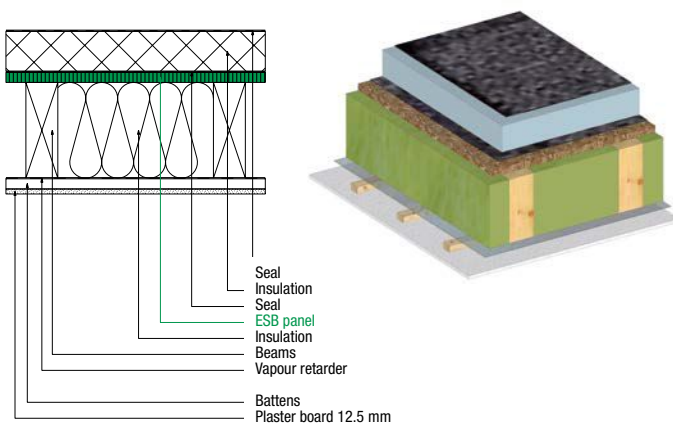

PRINCIPAL FEATURES

- + Timber components not at risk from condensation
- + Roof undersides can be produced ex-factory
- + Eaves can be produced using pitch rafters
- + Great thermal storage volumes through the use of solid timber components
- + Double seal above the esb panel protects insulation from the ingress of external humidity
- Greater component thicknesses by layering insulation and load-bearing system
- Compression-resistant insulation materials are required
- Secondary condensation may occur on the roof shell
- Routing of air sealing plane in connection area needs to be considered very carefully

4. Areas of application in timber construction¹⁾

esb in roofs

Roof 1 - esb panel providing a high degree of reinforcement

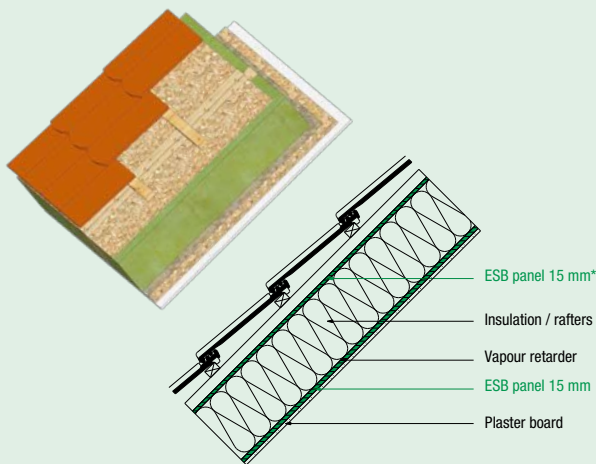

Roof 2 - wood fibre sarking board providing no reinforcement

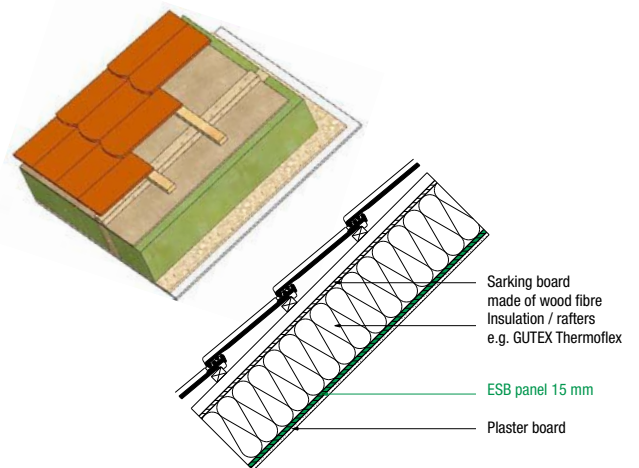

Roof 3 - esb panel providing a high degree of reinforcement

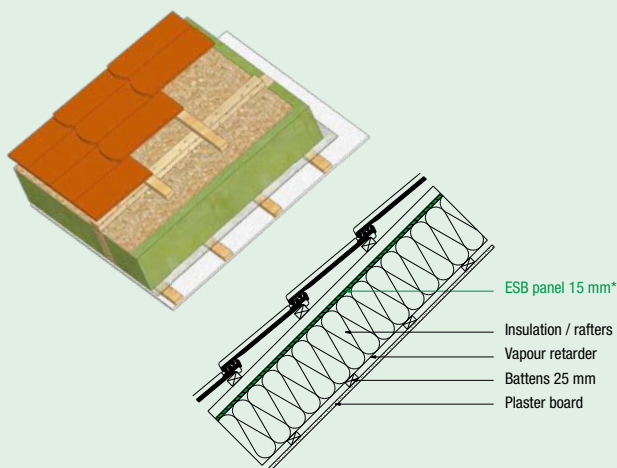

Roof 4 - during renovations

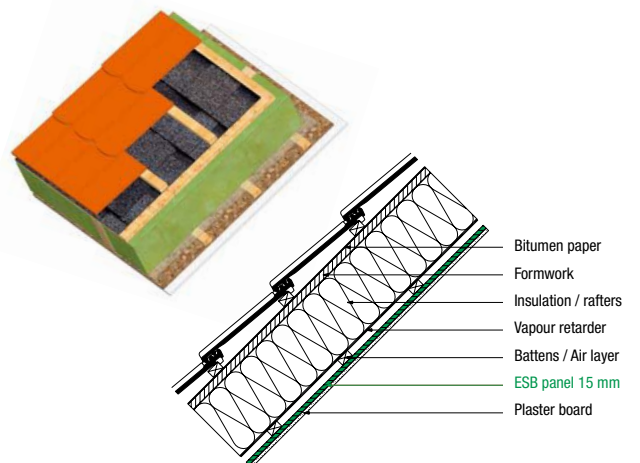

Both roofs can be used as an T+G sarking board in accordance with ZVDH/Cologne

* Acc. to test report from Holzforschung Austria [Timber Research Austria]: 2518/2014/1 (ingress protection) – 2518/2014/2 (rainproof properties) Butt joints must be fitted with adhesive tape in acc. with approval requirements.

¹⁾The structures illustrated in wall, ceiling and roof are just shown by way of example. They do not replace the physical structural calculation of specific buildings, that take all local conditions into account. The examples shown here provide information without assuring any properties.

5. Technical properties

Performance declaration, esb standard

according to Regulation (EU) No. 305/2011 of the European Parliament and Council of March 9, 2011

Designation (1)	P5 esb S 6-10	P5 esb S 10-13	P5 esb S 13-20	P5 esb S 20-25	P5 esb S 25-32
Thickness	>6 to 10 mm	>10 to 13 mm	13 to 20 mm	>20 to 25 mm	>25 to 32 mm
Bending strength	18.0 N/mm ²	18.0 N/mm ²	16.0 N/mm ²	14.0 N/mm ²	12.0 N/mm ²
Bending strength (modulus of elasticity)	2550 N/mm ²	2550 N/mm ²	2400 N/mm ²	2150 N/mm ²	1900 N/mm ²
Quality of the adhesive bond	NPD (2)				
Transverse tensile strength	0.45 N/mm ²	0.45 N/mm ²	0.45 N/mm ²	0.40 N/mm ²	0.35 N/mm ²
Durability (swelling)	13%	11%	10%	10%	10%
Durability (moisture resistance, option 2)	0.15 N/mm ²	0.15 N/mm ²	0.14 N/mm ²	0.12 N/mm ²	0.11 N/mm ²
Formaldehyde emission	E1E05				
Reaction to fire:	D-s2,d0 (1)				
Water vapour permeability μ: (4)	Dry / Damp = 80/40				
Airborne sound insulation: (4)	NPD (2)	NPD (2)	NPD (2)	NPD (2)	NPD (2)
Sound absorption coefficient: (4)	0.10 / 0.25	0.10 / 0.25	0.10 / 0.25	0.10 / 0.25	0.10 / 0.25
Thermal conductivity λ: (4)	0.12 W/(mk)	0.12 W/(mk)	0.12 W/(mk)	0.12 W/(mk)	0.12 W/(mk)
Structural Strength (average): acc. DIN EN 12369-1:2001	>6 to 13 mm	>6 to 13 mm	>13 to 20 mm	>20 to 25 mm	>25 to 32 mm
– bending:	15.0 N/mm ²	15.0 N/mm ²	13.3 N/mm ²	11.7 N/mm ²	10.0 N/mm ²
– tension:	9.4 N/mm ²	9.4 N/mm ²	8.5 N/mm ²	7.4 N/mm ²	6.6 N/mm ²
– compression:	12.7 N/mm ²	12.7 N/mm ²	11.8 N/mm ²	10.3 N/mm ²	9.8 N/mm ²
– shear perpendicular to panel plane:	7.0 N/mm ²	7.0 N/mm ²	6.5 N/mm ²	5.9 N/mm ²	5.2 N/mm ²
– shear in panel plane:	1.9 N/mm ²	1.9 N/mm ²	1.7 N/mm ²	1.5 N/mm ²	1.3 N/mm ²
Stiffness (average) acc. DIN EN 12369-1:2001					
bending:	3500 N/mm ²	3500 N/mm ²	3300 N/mm ²	3000 N/mm ²	2600 N/mm ²
tension and compression:	2000 N/mm ²	2000 N/mm ²	1900 N/mm ²	1800 N/mm ²	1500 N/mm ²
shear perpendicular:	960 N/mm ²	960 N/mm ²	930 N/mm ²	860 N/mm ²	750 N/mm ²
Thickness-independent properties					
Mechanical durability, deformation coefficient (NKL 1 (3)):	kdef = 2.25				
Mechanical durability, deformation coefficient (NKL 2 (3)):	kdef = 3.00				
Impact of loads					
Mechanical durability, creep factor, (NKL 1), all thicknesses		continuous: kmod = 0.30	long: kmod = 0.45	medium: kmod = 0.65	short: kmod = 0.85
Mechanical durability, creep factor, (NKL 2), all thicknesses		continuous: kmod = 0.20	long: kmod = 0.30	medium: kmod = 0.45	short: kmod = 0.60
PCP content	≤ 5 ppm				

HARMONISED TECHNICAL SPECIFICATION IN ACC. WITH DIN EN 13986:2005-03

¹⁾ Designation for identification of construction products in acc. with Article 11 Para. 4, only valid for panel thicknesses of 9 mm and more ²⁾ NPD = no Performance determined ³⁾ NKL = service class acc. DIN EN 1995-1-1 ⁴⁾ The product for which this performance is declared, is for the most part made from natural wood. Therefore, the properties indicated with (4) are subject to the variations caused by wood and thus do not constitute a reason for a claim.

5. Technical properties

Table of loads

THICKNESS: 12, 15, 18, 22, 25, 30 mm
TYPE: esb P5 on beam ceiling, uniform loading

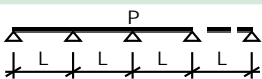
Weight + floor lining		0.20						
Working load in kN/m ²		1.00	2.00	3.00	3.50	4.00	4.50	5.00
Centre distance L of beams in mm		Type of load: 						
6-field	400	12	12	12	15	15	15	15
6-field	450	12	12	15	15	18	18	18
5-field	500	12	15	18	18	18	18	18
4-field	550	15	15	18	18	22	22	22
4-field	600	15	18	22	22	22	22	25
4-field	650	15	18	22	22	25	25	25
3-field	700	18	22	25	25	25	30	30
3-field	750	18	22	25	30	30	30	30
3-field	800	22	25	30	30	30	-	-
3-field	850	22	25	30	30	-	-	-
2-field	900	22	25	30	30	-	-	-
2-field	950	22	25	30	-	-	-	-
2-field	1000	25	30	-	-	-	-	-
1-field	675	22	25	30	30	-	-	-

Basis for calculation

w Q inst ≤ L/300

w fin ≤ L/200

σ md/f md ≤ 1

in acc. with EN 1995-1
and EN 312-5

with load as design values!

k mod = 0.45; NKL 2; KLED: medium

k def = 3.0; coefficient ψ2= 0.3

E mean acc. to EN 312-5

E *l = (E mean / δ M) * (1.00m * d³)/12; d = thickness of panel;

δ M= 1.3

This table provides non-binding preliminary measurement of the thickness of esb P5 panels for the stipulated load. This does not replace the physical structural calculation of specific buildings, that take all local conditions into account.

6. Recommended applications

1. Air seal



MOLL bauökologische Produkte GmbH
Rheintalstrasse 35 – 43 | 68723 Schwetzingen
Tel.: +49 (0) 62 02 - 27 82 - 0 | www.proclima.de

The product to recommend from pro clima is the INTELLO vapour retarder and air sealing strip.

For subjects associated with the building physics – WISSEN wiki von pro clima (www.wissenwiki.de)

2. Insulation slabs and composite thermal insulation systems



GUTEX Holzfaserplattenwerk | H. Henselmann GmbH + Co KG
Gutenberg 5 | 79761 Waldshut-Tiengen
Tel.: +49 (0) 77 41 60 99 - 125 | www.gutex.de

The product to recommend from GUTEX is Thermoflex insulation.



StoSE & Co. KGaA
Ehrenbachstrasse 1 | 79780 Stühlingen
Tel. +49 (0) 77 44 57 - 0 | www.sto.de

Exemplary product from Sto in external wall 4, page 6.



For insulation made of jute and hemp fibre
Thermo-Natur GmbH & Co. KG
Industriestrasse 2 | 86720 Nördlingen
Tel.: +49 (0) 9 081 80 500 - 65 | www.thermo-natur.de

3. Retaining components



ITW Befestigungssysteme GmbH
Carl-Zeiss-Str. 19 | 30966 Hemmingen
Tel.: +49 (0) 5 11 42 04 - 265
www.itw-haubold.de

Steel wire clip	Stapler PN 755	Stapler PM 765
Type	KG 745, CNK, resin-coated 'Z'	
Standard	DIN 1052-10	
Size	45 mm	

4. Ecological colours and clay products



Keimfarben GmbH
Keimstrasse 16 | 86420 Diedorf
Tel.: +49 (0) 8 21 - 48 02 - 0 | www.keim.com



Clay products:
Thermo-Natur GmbH & Co. KG
Industriestrasse 2 | 86720 Nördlingen
Tel.: +49 (0) 9 081 80 500 - 65 | www.thermo-natur.de

6. Recommended applications

5. Surface coating



Remmers GmbH
 Bernhard-Remmers-Str. 13 | 49624 Lönigen
 Tel.: +49 (0) 54 32 83-0 / Dept. Remmers Technical Service (RTS)
 www.remmers.de

Interior (wall / ceiling)	Interior (floor)	Exterior varnishing	Exterior covering (white, bright colours)	Exterior covering (medium and dark colours)
Living room varnish	HWS-112	HSL- 30/m-Professional timber protection varnish	IG-10-Impregnating, colourless + 3 x Aqua VL-66/sm- Venti-paint 3in1	IG-10-Impregnating primer colourless + 2 x Rofalin acrylic
HWS-112	Wood floor tile lacquer PL 413	HSL-30/m-Professional timber protection varnish + long-term lacquer	IG-10-Impregnating primer colourless + 2 x insulation primer + 1 x Rofalin acrylic	
		HSL-30/m-Professional timber protection lacquer + Aqua MSL-45/sm medium-layer lacquer		

6. Recommended adhesive



SCHÖNOX GmbH
 Alfred-Nobel-Str. 6 | 48720 Rosendahl
 Tel.: +49 (0) 25 47 910 - 325 | www.schoenox.com

Substrate preparation				
Substrate	Type ELKA esb P5 lay plates (specialist installation in acc. with TKB instructional pamphlet 10)			
Type of laying	adhesively bonded & bolted		floating layer	
Primers (examples)	SCHÖNOX® VD (EC1 PLUS), SCHÖNOX® HP RAPID (EC1 PLUS R), SCHÖNOX® SHP (EC1 PLUS)			
Fillers (examples)	SCHÖNOX AM® (EC1 PLUS) SCHÖNOX APF® (EC1 PLUS)	SCHÖNOX ZM® (EC1 PLUS R) SCHÖNOX ZMF® (EC1 PLUS R)	SCHÖNOX® APF (EC1 PLUS)	
Adhesive bonding of lining				
Lining	PVC / CV*	Linoleum*	Textile coverings*	Wooden floor tiles**
Recommended adhesive	SCHÖNOX® DUROCOLL Fibre-reinforced, one-sided Emulsion adhesive (EC1 PLUS)	SCHÖNOX® LINO XTREME Very low-emission linoleum emulsion adhesive (EC1 PLUS)	SCHÖNOX® TEX OBJEKT® Textile covering emulsion adhesive (EC1 PLUS)	SCHÖNOX® MSP CLASSIC Very low-emission, flexible and water-free adhesive for wooden flooring (EC1 PLUS)
SCHÖNOX® EMICLASSIC® Very low-emission universal emulsion adhesive (EC1 PLUS)				SCHÖNOX® PARKETT 600 Very low-emission, hard, water-free universal SMP adhesive for wooden flooring (EC1 PLUS)
Applicator	Serration TKB A1	Serration TKB B1		Serration TKB B6 - B15
Consumption	approx. 250 - 300 g/m ²	approx. 400 g/m ²	approx. 400 g/m ²	approx. 750 - 1250 g/m ²

7. Delivery range and service

Tongue and groove format

258 cm x 67.5 cm / coverage
258 cm x 125 cm / coverage¹⁾
205 cm x 62.5 cm / coverage¹⁾

Flush-type format

259.5 cm x 125 cm ¹⁾
280 / 300 cm x 125 cm in 15 mm ²⁾

Large flush format

520 cm x 206 cm ¹⁾ in
9^{**}) / 12 / 15 / 18 / 22 / 25 mm
(can already be supplied from 80 units /
thickness)

^{**}) from 350 pcs / 1 truck load

Material thicknesses / Pack units

9 mm	after consultation
12 mm	75 units
15 mm	60 units
18 mm	49 units
22 mm	40 units
25 mm	36 units
30 mm	30 units

¹⁾ not including 30 mm

²⁾ only in esb Plus for walls

*Non-standard dimensions
available upon request*



On our esb blog (esb-blog.elka-holzwerke.de – in German), we regularly publish examples of applications and questions from users. We particularly welcome your posts with comments, questions and photos of applications.



Our elka service team is there to answer your questions

elka-Holzwerke GmbH has a proud company history that stretches back over 100 years. Professionally trained staff and modern production technologies guarantee the high standard of quality that elka® brand products provide.



The logo for 'estb' is displayed in a bold, green, sans-serif font with a horizontal line underneath, set against a yellow rectangular background.The logo for 'elka' is in a bold, yellow, sans-serif font with a registered trademark symbol, positioned above the words 'Brand products' in a smaller, yellow, sans-serif font, all on a green rectangular background.

**Are you already familiar with the complete elka® variety?
Contact your local specialist retailer for advice!**

Sawn timber



Chipboard



Natural wood panels



Decking & fencing



Your authorised dealer would be delighted to advise you:

ecomat .be
info@

Warranty disclaimer. Subject to technical changes and printing errors. Reproduction only with the express approval of elka-holzwerke GmbH. All the information provided in this brochure serves as a guide and is for information only. It does not therefore constitute a guarantee of the particular qualities featured.

04/2020 - odt.de

elka-Holzwerke GmbH – Hochwaldstrasse 44 – D-54497 Morbach

Tel.: +49 (0) 65 33 / 9 56-332 – Fax: +49 (0) 65 33 / 9 56-330

e-mail: vertrieb@elka-holzwerke.de – website: www.elka-holzwerke.eu

